

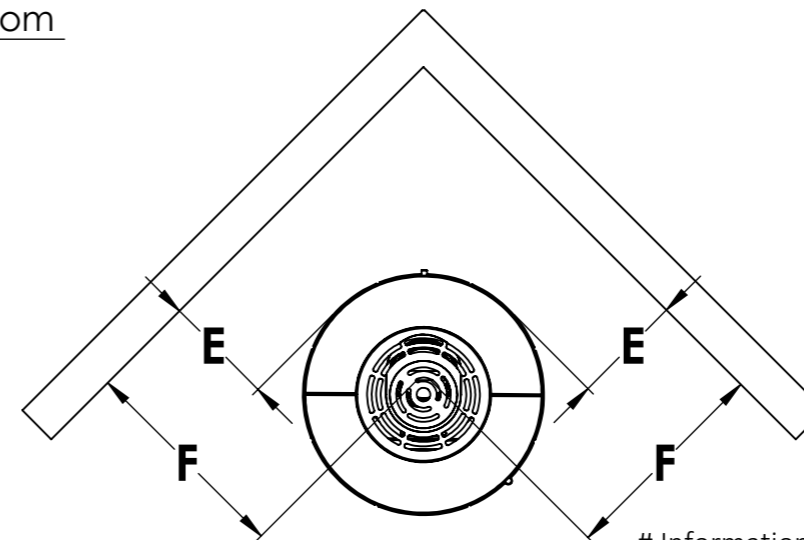

Serie	Scan-Line 10-20-20B-30-30B
Description	Scan-Line 30

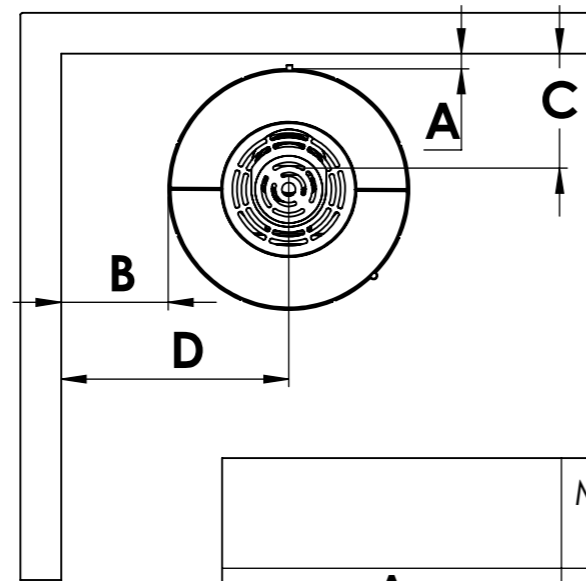
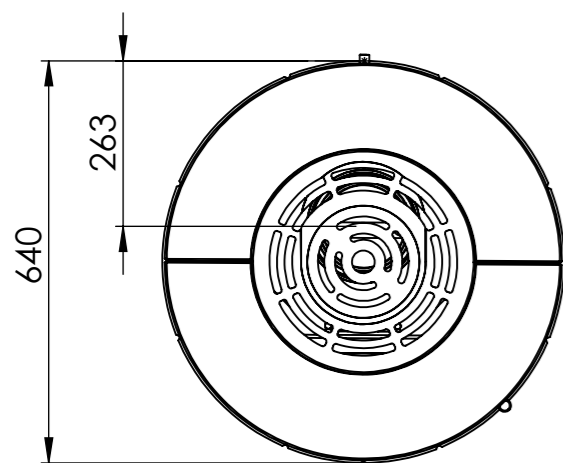
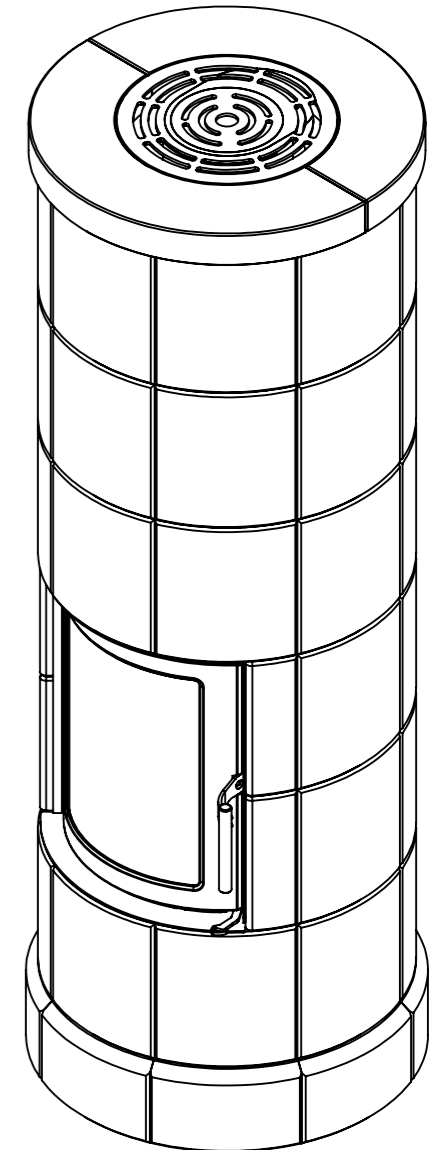
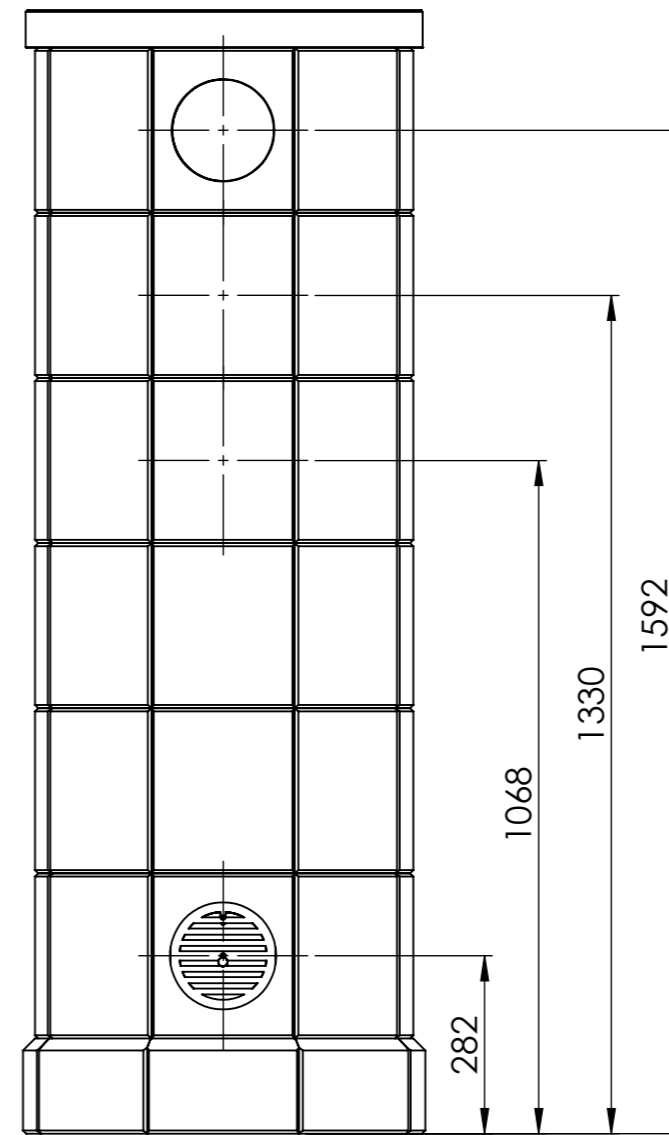
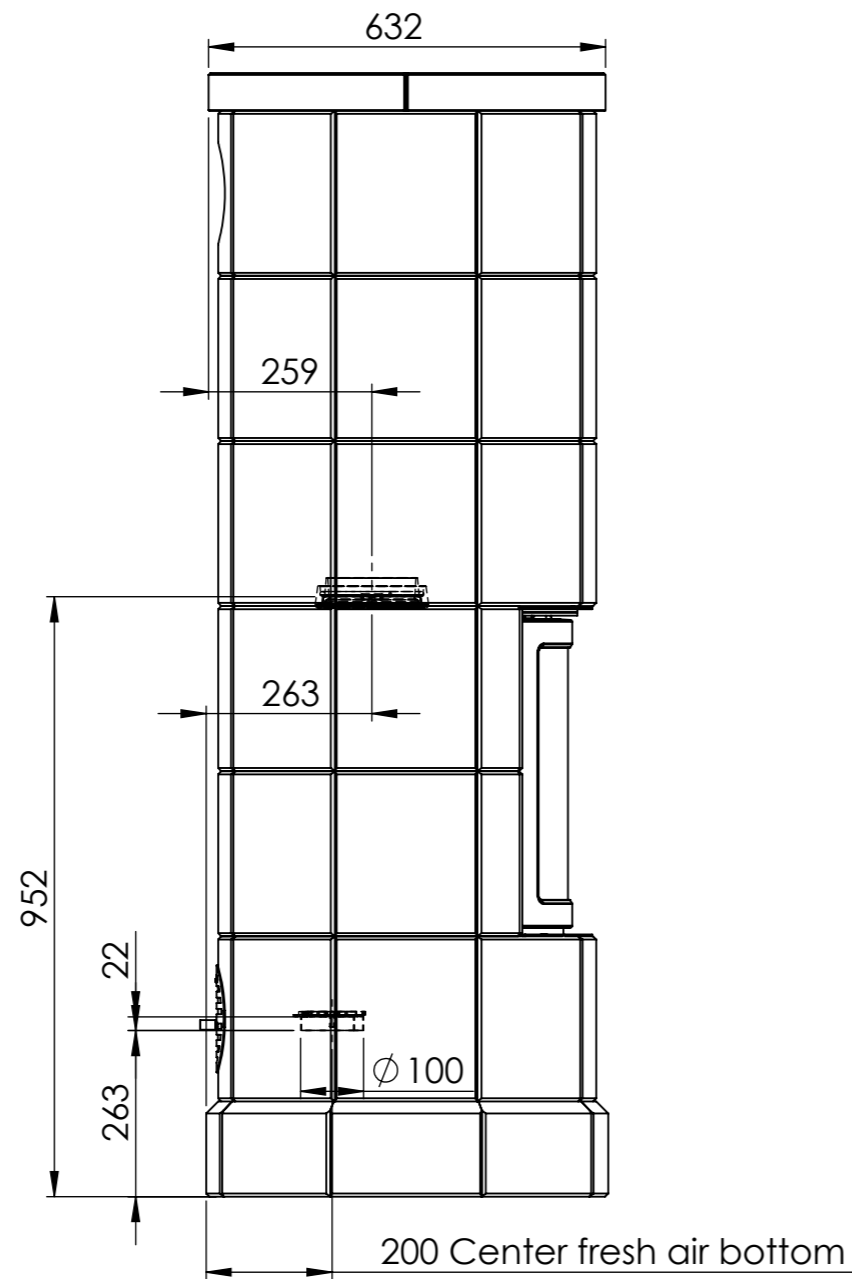
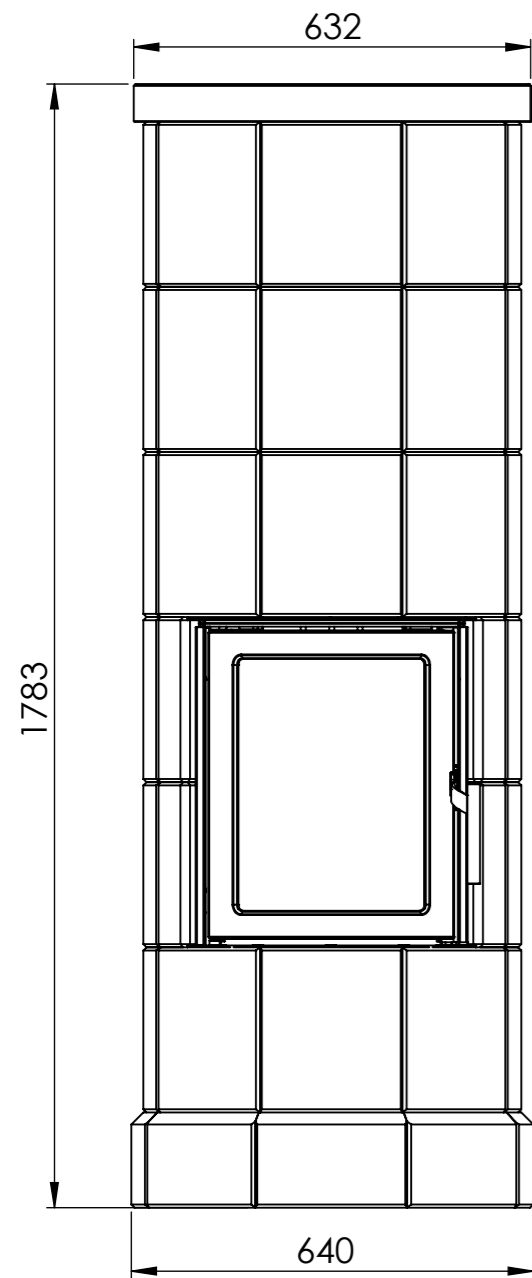

	Minimum distance #	Distance according to EN 13240
A	40	150
B	283	350
C	303	413
D	602	669
E	293	350
F	573	629

Information on Minimum distance

EN: If Heta's minimum distance to combustibles is used. The installation must always be approved by the local authorities (chimney sweep) before starting installation of the stove.

DK: Hvis minimumsafstand til brændbart anvendes, skal dette altid godkendes af de lokale myndigheder (skorstensfejer) inden montage af ovnen påbegyndes.

DE: Wenn sie den Mindestabstand zu brennbaren Material nutzen möchten, muss dies immer von den örtlichen Behörden (Schornsteinfeger) genehmigt werden, bevor mit der Installation des Ofens begonnen wird.