

PRIME FIRE 2.0 590

WITH FRAME & GLASS PANELS *(for Room Divider, Tunnel and Island housings)*

Net Zero automatic burner with the BEV Technology[®]



FRAME WITH GLASS PANELS

The frame with glass panels serves as a protective and aesthetic mantle for the burner. Designed to cater for multiple arrangement styles, it enables tunnel, room divider, and island configurations.



REMOTE CONTROL

Easily control your fireplace with the handy remote. You're in charge of the flames. Go for one of 3 flame levels to adjust the ambience and coziness to your needs.



AUTOMATIC REFILLING

The automatic pump communicates with the device, delivering the necessary amount of fuel. There is no risk of overfilling the tank or spilling the fuel.



INTEGRATED CONTROL PANEL

Experience the ultimate convenience with the integrated control panel, featuring an intuitive design that lets you effortlessly adjust the flame height to create the perfect ambience.



MOBILE APP

A fireplace controlled by an app offers the convenience of adjusting flame settings and ambience remotely, enhancing comfort and ease of use.



OPTIONAL DECORATIVE LOGS

Enhance your fireplace's aesthetic with our optional tray of new decorative logs, adding a touch of elegance and warmth to any room.

Prime Fire 2.0 590

(BEV Technology®)

Fuel tank capacity	3.1 L
Maximum burn time	5 hours
Maximum heat output	3.1 kW
Minimum room cubature	31 m ³
Flame height regulation	3 stages
Weight	19.9 kg
Fuel type	bioethanol 95 - 96,6%
Flue	not required
Air change rate	1 space volume per hour
Power supply	230 V
Finish	black powder coating
Materials	steel, galvanized steel, tempered glass
Application	for indoor use only

CONTROL OPTIONS



included



included



optional

'PLANIKA BEV' APP

Control the fire with your smartphone!

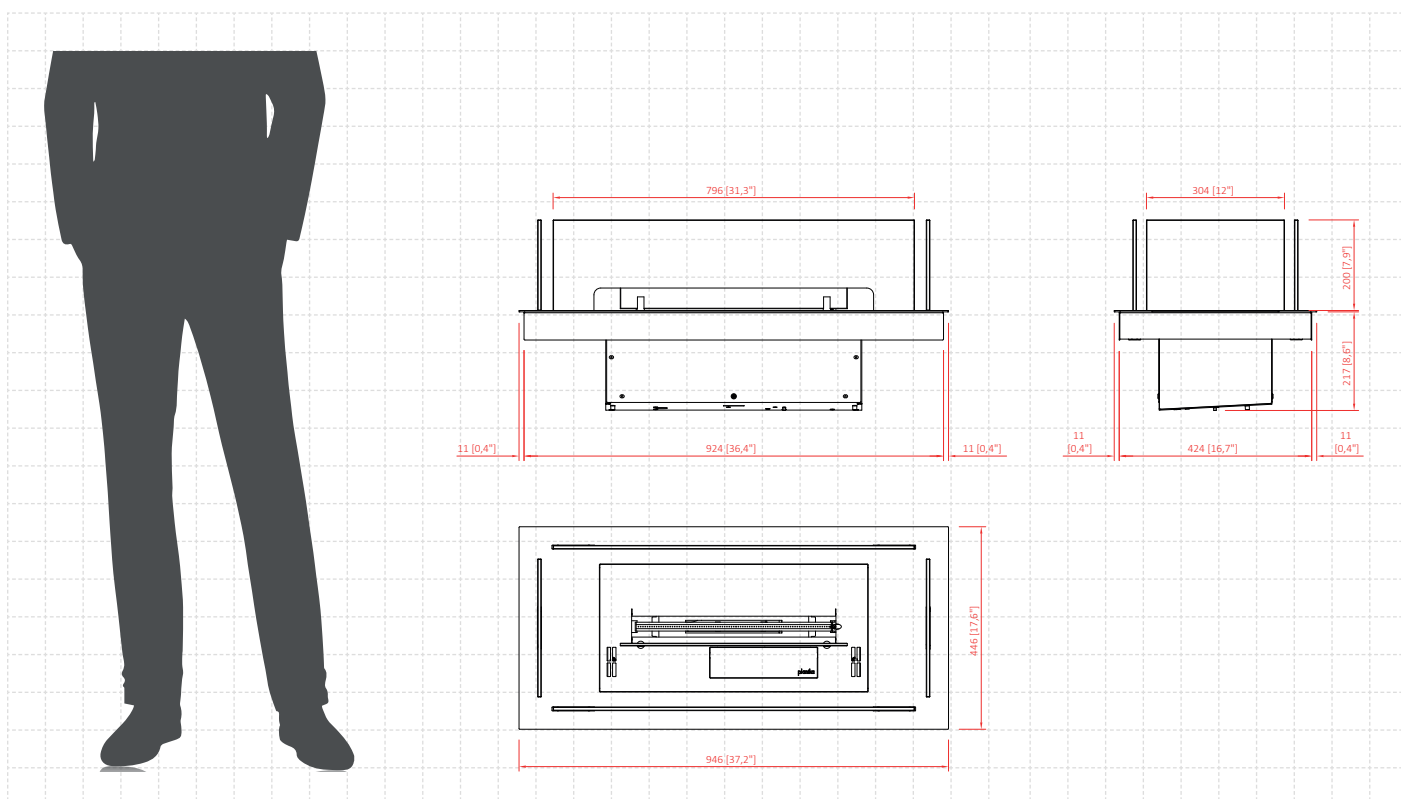

All product specifications and data are subject to change without notice and are believed to be accurate as of the date hereof. Planika Sp. z o.o., its affiliates, agents, and employees, and all persons acting on its or their behalf (collectively, "Planika Sp. z o.o."), disclaim any and all liability for any errors, inaccuracies or incompleteness contained in any document or in any other disclosure relating to any product. To the maximum extent permitted by applicable law, Planika Sp. z o.o. disclaims any and all liability arising out of the application or use of any product. No license, express or implied, by estoppel or otherwise, to any intellectual property rights is granted by this document or by any conduct of Planika Sp. z o.o.. Customers using or selling Planika Sp. z o.o.'s products not expressly indicated for use in such applications do so entirely at their own risk and agree to fully indemnify Planika Sp. z o.o. for any damages arising or resulting from such use or sale. The provided fuel consumption is based on laboratory testing on the lowest flame level. The actual consumption of individual devices may vary. The images are indicative only.